

**DentalDeal**



Ver1.0 Revision Date:2012-12-27

Implant system

# Usage manual

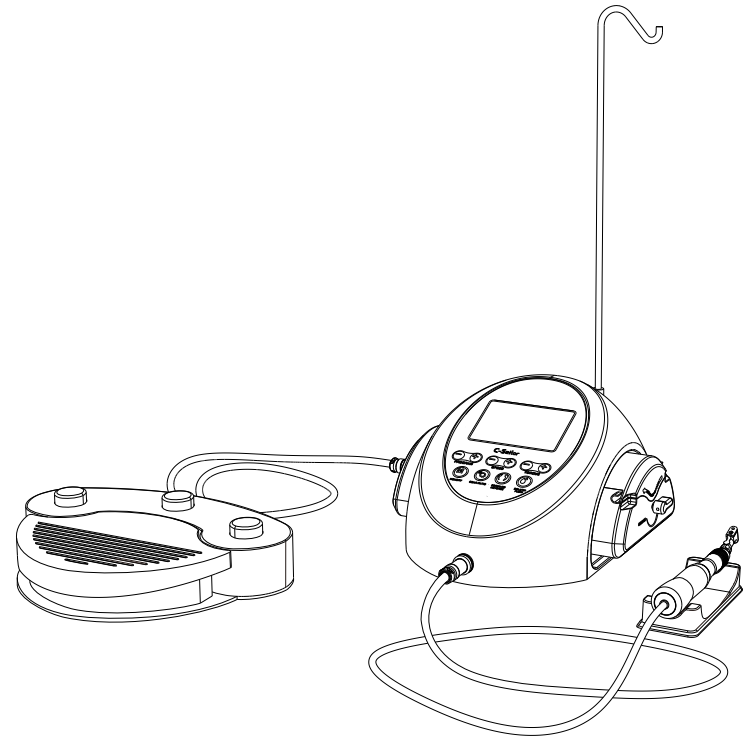

This product is used in stomatology, Oral Surgery and surgery dynamical system.  
This product is designed for dental surgery (implant surgery) and as a dynamic system for the handpieces.  
Please read this manual carefully before your operation for safety.  
Please keep the manual in the place that convenient for you to read.

Usage: Use in perforate the E-bone or drill the hole in implant material when doing oral implantology.

**Prohibitions:**

- Please change the burs or loading/unloading the handpiece after the motor stop rotating.
- Please wash, add the oil(not include the motor),high pressure and temperature sterilized (may lead to the blood solidification)after operation.
- There will be some incorrect operation under the Electromagnetic wave environment .It is not allow to put the implant system near the Electromagnetic wave machine.
- Please turn of the major unit when using the electric knife.

**Division of category of machine**

Protect measure against electric shock:

- Class I

Protect degree against electric shock:

- BF type 

Manufacture recommended sterilized method

- Please refer to 8 for high pressure and temperature sterilization.
- Divide according to IEC 60529 the degree against harmful liquid intrude
- Pedal: IPX4
- The safety degree according to the usage in the air, Combustible gas anesthesia,oxygen, Time nitrogen oxide

- Motor,foot control: AP machine 

Operate mode

- Continuous operate machine

**Catalogue**

- Notice for safety and dangerous operation.....3
- Feature.....4
- Part list.....5
- Major control unit.....6
- Foot switch.....8
- Connect method.....9
- Operate method.....14
- Method of use.....15
- Maintenance.....16
- Sterilization.....19
- Technical specifications.....21
- Symbol definition.....21

## ⚠ Notice for safety operation and avoid dangerous usage

- Please read all the notice as following and have the correct operate method well in hand before using.
- Please follow the notice when during your operation, in case of doing any harm to you or other people. The items as following are divided according to the risk degree, all related to safety and need to be noticed, please read carefully and abide with it.

Notice classification	The contingent risk, harm and ponderance degree
⚠ Warm	It means something that may lead to be harmful to people or object
⚠ Attention	It means something that may lead to be less harmful to people or object
⚠ Bulletin	Please abide with the attention for safety

### ⚠ Warm

It maybe lead to incorrect operation under the environment of Electromagnetic obstacle wave. Please do use this machine near Electromagnetic obstacle wave. If there any ultrasonic machine or electric knife nearby, please turn off the switch.

### ⚠ Attention

- This products can be only used by certified stomatological or oral surgical dentists
- For the safety of the patient, please be careful while operating this machine.
- Please read this manual and learn all the functions of every part before using.
- Please check every part of the machine and make sure it is in good condition before using.
- Please make sure the machine can work properly before using.
- When some abnormal condition (vibration, too hot or noise) happens before or during the operation, please stop at once.
- Please prepare some spare parts for back up.
- Please use the electric plug with ground wire
- Please load/unload the burs and handpiece after the motor stop rotate, in case of hurting people or destroying the connection of the handpiece.
- Please avoid crushing the handpiece, especially falling down to the floor, it may cause the machine malfunction.

- When the water supply pump working, please don't twist the water pipe, or else it will be damaged or fall off.
- Please don't disassemble or modify the design of the machine.
- Please wash, oiling, sterilize the handpiece after treatment
- Please avoid oiling the motor, in case of overheating and malfunction.
- Please don't sterilize the major unit and foot pedal in any way.
- Please turn the power off, dry the rag and wipe while cleaning the major unit.
- Please avoid using the diluent or volatile for cleaning.
- Please avoid disassembling the motor and motor wire.
- Please deal with the water supply pipe as disposable.
- Please put this machine under the environment, which the temperature is 0-40 degree, 10%-85%RH pressure 500-1060hPa. Otherwise, it will cause the machine malfunction.

### ⚠ Bulletin

- Please power off after using.
- Please contact the supplier for repairing or changing the spare parts
- Please keep this machine stay out of dirt, sulphur, salt, and put under the environment, which the temperature is 10-60 degree, 10%-85% RH, the air pressure is 500-1060hPa.

## Feature

- 210W high efficiency, 55N/cm high torque electric motor, less noise and vibration.
- The speed of the motor: 300-50,000 rpm
- Big screen can identify all operational programs quickly. 10 memory programs.
- The electric motor can be sterilized within high pressure and temperature.
- The new foot pedal meet the International waterproof standard
- IPX4, it can control the speed, select the programs, adjust the output of water supply, and change the direction of the rotary.

**Part list**

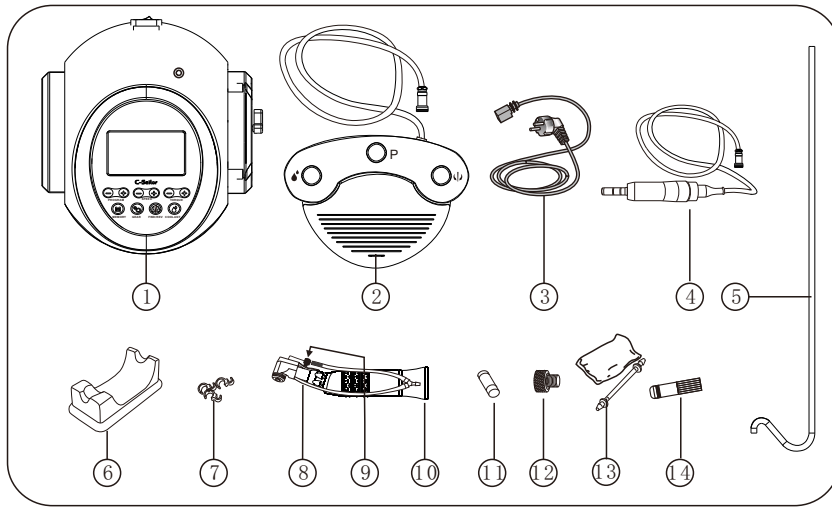

	Name	Quantity
①	Major control unit	1
②	Foot Pedal	1
③	Power cord	1
④	Motor with wire	1
⑤	Water supply bottle holder	1
⑥	Motor holder	1
⑦	Pipe clasp	8
⑧	Y type isocon	1
⑨	Internal waterspray nozzle	1
⑩	Contra angle for Implant	1
⑪	Fuse	1
⑫	Prevent steam bolt	1
⑬	Water supply pipe	1
⑭	Nozzle for contra angle	1

**Main control unit**

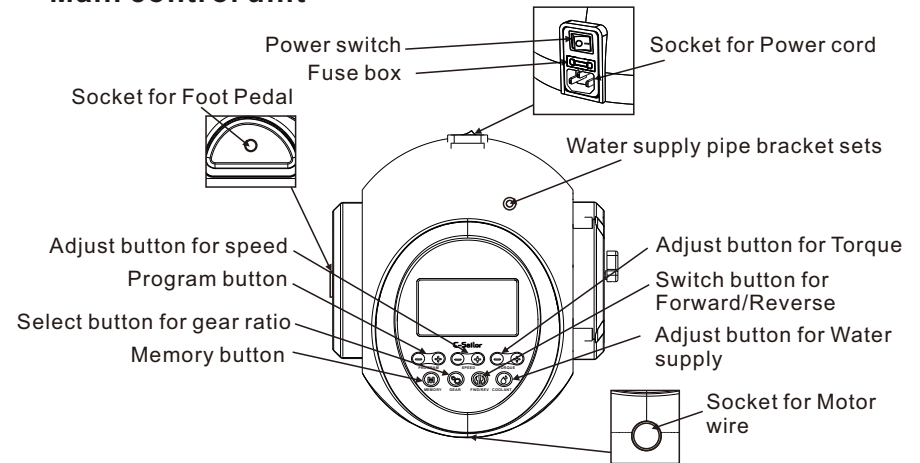

**Specification for operate system**

**Program button**

This button can select the programs, use the (+) and (-) to select between the different programs.

**Adjust button for speed**

This button can adjust the speed of the motor, Press (+) the speed will increase 1 level, press (-) will decrease 1 level, When it reaches the lowest or the highest speed, it will start beeping continuously to tell it can not be changed any more. The maximum and minimum of the speed will change according to the selected gear ratio.

**Adjust button for Torque**

This button can select the Torque of the motor, Press (+) the torque will increase 1 level, press (-) will decrease 1 level, When it reaches the lowest or highest torque, it will start beeping continuously to tell it can not be changed any more. The maximum and minimum of the Torque will change according to the selected gear ratio.

## Select button for gear ratio

This button can set the gear ratio correspond to the current connected handpiece, the major control unit will show the current gear ratio when press the button.

## Adjust button Water supply

This button can decide supply amount of the water. There are 5 levels for choose, you can also choose different water supply mode.

## Switch button for Forward/Reverse

This button can change the working direction of motor, it will change when press it.

## Memory button

The memory button is use for memory all the settings that the operator set. Press this button for 1 second can storage the current program. when the beeper come, it means the program has already been memoried.

## LCD Display:

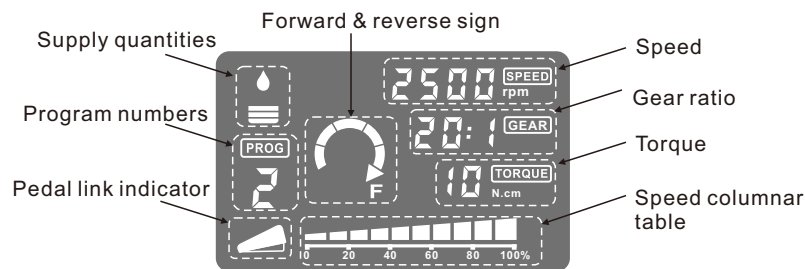

## The water supply display

It shows the level of the current set water supply. If there's no indicate light among 5 level, that means no water supply.

## Program number display

Indicate the current set program.

## Speed proportion display

It shows the selected gear ratio.

## Forward/Reverse display light

Show the forward or reverse condition.

## Speed

It shows the current set speed and the speed while operating.

## Torque

It shows the current set Torque and the Torque while operating.

## Speed column

It shows the condition of current speed. When all the column are lighted, it means it achieves the maximum speed. When 50% of the column are lighted, it means the speed and torque only achieve 50%.

### ⚠ Notice:

Please avoid placing heavy object onto the screen or crushing it, otherwise, it will be damaged.

## Foot switch

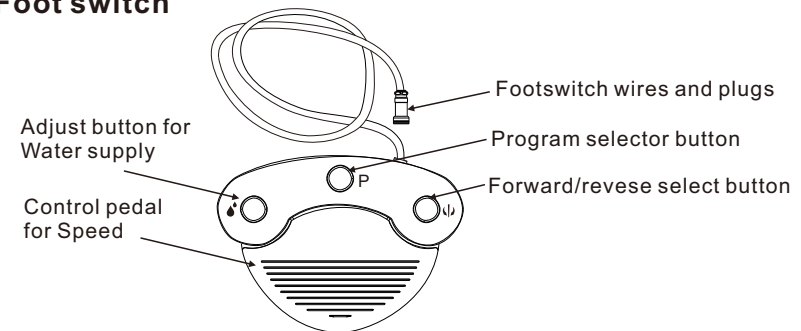

## Adjust button for Water supply

This button use in the current water supply, there are 5 level for select. It can increase 1 level when press the button. After reach its maximum, it will return to level 0, and supply no water.

## Select button for Program

This button is for selecting the program number, each step on it, and the program number will increase 1 by 1. After program number 9, step on pedal again, the program number from 9 back to 0. In addition, press the pedal for more than one second, the program number down to one.

## Control pedal for Speed

This pedal can start or stop the motor. Press this pedal to start the motor, release the pedal, the motor will stop running, and can adjust the running speed.

## Forward/reverse button

This button is to change the running direction of the motor, each step can change the running direction.

## Connection method

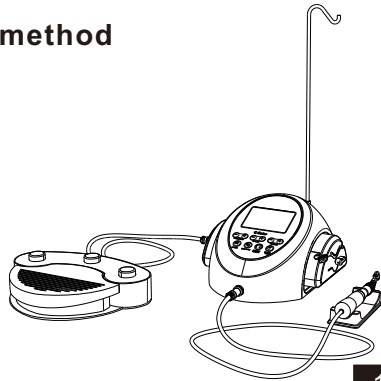

## Motor connection

Plug the Motor cord into the motor interface of the main unit, fasten the Fixed nut after that. When remove the motor cord, loosen the fixed nut, pull out the plug from the interface.

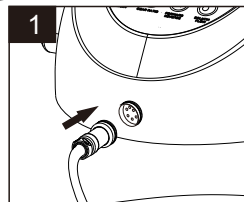

## Foot switch connection

Insert the plug of the foot switch according to the shape of the interface, and then fasten the fixed nut.

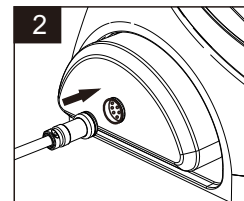

9

## Power line connection

Insert the power cord according to the shape of the interface of the main unit.

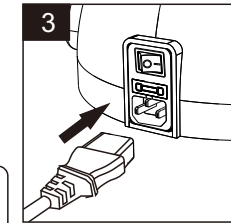

## ⚠ Notice:

Please make sure the motor and foot pedal are well connected before open the main control unit.

## Water supply pipe connection:

1. Please connect the water supply pipe 1 and pipe 2 (see picture);

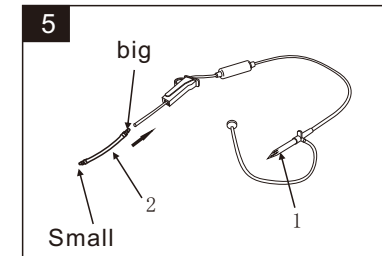
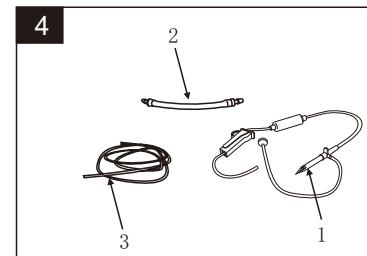

2. Then connect the water supply pipe 3 and pipe 2 (see picture);

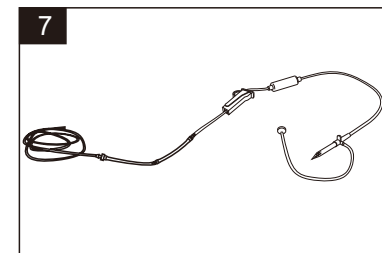
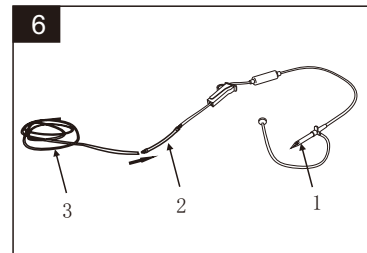

10

## Water supply pipe installation method

Please install the water supply pipe onto the side of the main unit. Then please send water supply pipe needle side of the clamp ring alignment host back in, it will be another clamp ring alignment water supply pipe guide of the load.

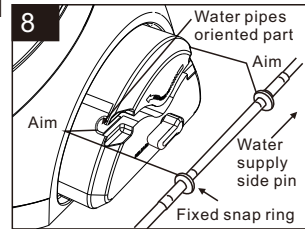

9

### Note:

Please make sure the water supply parts in the rotating shaft, then close the cover of the pump. It will damage the water supply pipe if it is not in the correct position.

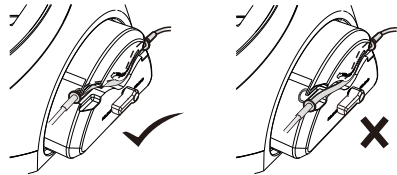

When close the cover for the pump, turn the handle on the water supply pump to the right for 180 ° degrees until it reaches the horizontal line.

## Water bottle installation method

First insert the water bottle support bracket in the hole which is located behind the main unit, then hang the water bottle onto the bracket.

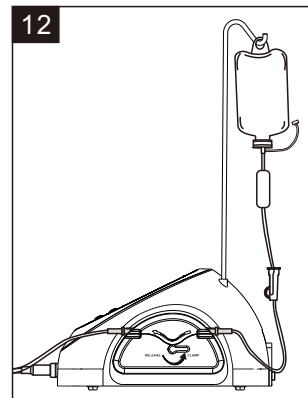
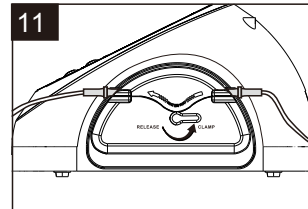
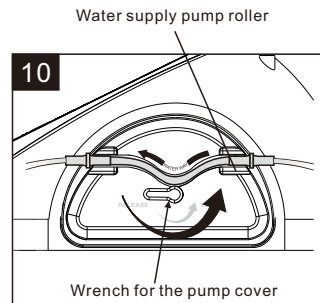

11

## Water supply pipe insertion

1. Will be in water supply pipe needle and feed pump of water supply pipe clamp between the closed tight.

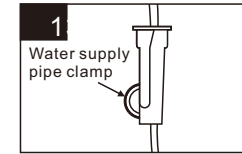

2. Insert the water supply pipe into the water bottle.

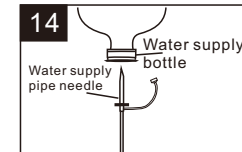

3. Loosen clip on the water supply pipe.

### Note:

If the water supply pipe is bent or held to tight, the water pump may damage the pipe while working and cause the water leak out.

## The compatibility of the internal nozzle

The internal nozzle of C - Sailor might not be compatible with some of the drills in the market. Therefore, please confirm the compatibility of the nozzle and the drill before using.

If the compatibility of the nozzle and the drill not been confirmed or operating while they are not compatible, that would cause the physiological saline leak out, and get inside the handpiece and the motor. And this result in the rust inside the machine, even sudden malfunction.

## Confirm method

### Preparation

1. Hang the water bottle that filled with physiological saline over the C-Sailor, install the water supply pipe to the water supply pump.
2. Select the same internal water drill for the nozzle, the water supply pipe connect to the internal water nozzle.

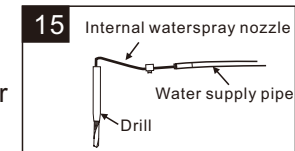

12

3. put the internal water nozzle into the back of the drill.
4. Adjust the amount of the water supply to its maximum, and last for 5 seconds.

### Confirmation of items:

1. Is the physiological saline that come from the drill clean.  
If the drill inside is rust, it may cause the color of the physiological saline become yellow. At this moment, please change a new drill.
2. Whether the water supply amount is suitable.  
If the water supply amount is too low, or the water amount from the front of the drill is not the same, it is probably because the water hole inside the drill was stuck by the bone dust. At this moment, please clean the drill or change a new one.
3. There should be no water leak out between the Internal water nozzle and the drill.

There's no seal components inside the drill or they are broken, that may cause the water leak out from the backside of the drill. The physiological saline flow inside the handpiece and cause damage. Therefore, before the operation, it's necessary to check the drill to see if the Drill has been sealed off.

**⚠ Note:** If find any abnormal such as the physiological saline leak out from the head of the handpiece, please stop operating and run a test.

- According to the bur or the treatment way, it's available for the both of the internal water nozzle and external water nozzle to work at the same time.
- Use the Y shape adaptor to connect the main water supply pipe, and then connect the other two kinds of the water supply pipes.

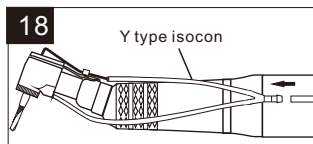
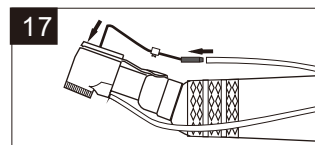
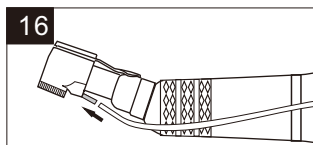

13

### Line card ring

Use line card ring, the motor line good water supply pipe. First the line card ring insert motor line, and then insert the water supply pipe can be (Picture 19).

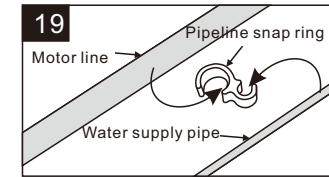

### Operation method

#### How to set the Program

This product can storage 10 sets of programs, which include the functions that mention below.

- The gear ratio of the handpiece
- Speed
- Direction of the rotation
- The maximum Torque
- The amount of the water supply
- Display of the speed or torque

1. Turn on the machine by push the button behind it, the button should turn to the [-] side. The screen will display all the contents exactly the same as the last time when the machine been shut down.

Power switch flag	○	—
Status	OFF	ON

2. Select the desired program number.  
According to the treatment, follow the a) or b) steps, to select the program number.
  - a) Press program button on the main unit to select the program.
  - b) Step on the program button on the foot control to select the program number.
3. Choose gear ratio of the handpiece, press the  button on the main unit to select the gear ratio according to the current handpiece.
4. Speed setting.  
Press speed button to set the speed.
  - Each press onto the speed button will turn to the next level of the speed. Continuously to press this button more than 1 second can rapidly turn to the desired speed.
  - When the speed reaches its maximum or minimum, the unit will start beeping, the speed will not be changed at this moment.

14

## 5. How to set the maximum Torque.

Press the torque button on the main unit to set maximum torque.

- Each tap on this button, the Torque will turn to the next level. Press the button continuously for more than 1 second will change more faster.
- When the torque reaches it's maximum or minimum, it will start beeping, the torque will not change any more at this moment.

## 6. Setting the water supply.

Use water supply button  to set the supply amount.

- There are six level of the water amount for choosing, include no water supply.

7. Select the control panel on the screen that can be expressed speed or torque. Press SPEED key SPEED or TORQUE key to select the desired TORQUE said that.

## 8. How to set the memory program.

When finishing the steps of (1) - (6), press the  button and hold it for more than 1 second until a long beep go off.

Repeating the steps above can finish all the program and all the functions included.

### Method of use

Foot control possesses all the functions for all the normal treatment. Except some special operation, the foot control can control all functions.

#### 1. Switch the power

In the screen will display all the operational details for the program 1.

#### 2. Select the program number

Step on the program button on the foot control, the program number in the display screen will increase by 1. Please select the desired program number. When select to the program 9, one more step on the program button, the program number will back to 0.

#### 3. Confirm setting details

Please confirm all the contents in the display screen. The number in the middle indicate the speed.

#### 4. Start running

Step on the speed pedal on the foot control, the motor will start running. The motor works slowly when the force on the speed pedal is slight, if the force increase, the speed of the motor will also increase accordingly. The water supply pump will work with

the motor at the same time when there is a setting for the water supply.

#### 5. Setting the limit of the Torque

With the function of the Torque control, when the load reaches it's limit, the Torque control will start working, the Torque will not exceed it's limit and the motor will stop running. A beep will go off at this moment. Press on the speed pedal once more will make the motor start again.

#### 6. Stop running

Loosen the speed control pedal, the motor will stop running.

#### 7. Convert the rotary direction

When the rotary need to be reversed, just step on the reverse button on the foot control. During the reverse mode, a beep will go off continuously.

### Maintenance

#### Protection of the circuit

When the load on the motor exceed its limit, for protecting the motor and the unit, a protection program will start working. The power source to the motor will be cut off, and a malfunction signal will also appear on the display screen.

#### How to remove the Protection circuit remove

Release the foot control and press it once again will remove the circuit protection.

Malfunction	Reason	Measures
System malfunction	- Memory components malfunction - Memory components damaged	Please contact with the seller
Over current	- Long time use under overload (over current) - Power cord short circuit - Motor coil short circuit	Probably the circuit is bad connected. Please connect the motor line properly. If still no improvement, please contact with the seller.
Overvoltage	Main power cord broken	
Motor sensor malfunction	- Motor sensor malfunction - Motor cord not been connected - Motor line (signal line) malfunction	Please contact with the dealers. (in high pressure high temperature sterilization, please be sure to install the anti-steam dossil.
	Water flow in to the motor	

The main unit inside overheat	<ul style="list-style-type: none"> <li>-Due to the long time use under overload, the temperature of the main unit arise.</li> <li>-To use the unit under the high temperature environment (direct sunlight)</li> </ul>	Please wait until the temperature is cool down before using. Please place it in the environment that easy to cool down. If still no improvement, please contact with the seller.
Braking device malfunction	<ul style="list-style-type: none"> <li>- Abnormal voltage appears during the start and stop.</li> <li>- Start and stop circuit malfunction</li> </ul>	In a short time repeated operation and stop,running, inhibit suddenly accelerated circuit may be start.Please wait for 1~2 seconds before operation. If still no improvement, please contact with the seller.
Motor running malfunction	<ul style="list-style-type: none"> <li>- Malfunction of the handpiece</li> <li>-Malfunction of the motor</li> </ul>	Probably the chuck is opened or not fully closed.If still no improvement, please contact with the seller.
	When the Torque reaches its limit, the stop process lasts for more than 5 second.	Not malfunction. It is for the safety. It can still be used after connect.
Water supply pump overvoltage	-Water supply pipe not been fully attached to the right place of the water supply pump	Please confirm the state of water supply pipe. If it is normal, but still appear the malfunction signal. please contact with the seller
Water supply pump over current	-Water supply pump malfunction	please contact with the seller
Foot control abnormal	Dad connection	Please confirm connection status
	Foot control inside malfunction	If the foot control is in normal, but still show the malfunction number, please contact with the seller

### Replacing the fuse

If there is no problem with the power source and the power cord, when turn on the power source, if the screen dose not show anything, please check the fuse. Please use the tools to open the fuse box behind the unit and take it out.

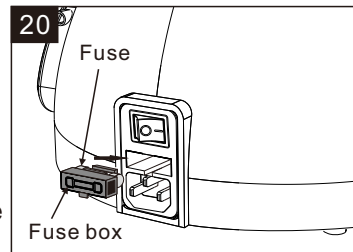

### The maintenance of the unit and foot control

When there is blood or physiological saline on the unit and foot control, please take out the power cord, use a clean and dry rag to clean it, and then use the alcohol to clean it again.

### Maintenance of the Handpiece

Every time after treatment, please put the head of the handpiece into the clean water and rotate for 4-5 seconds, to clean the blood and physiological saline. If the attachments on the handpiece is too much, use the dry and soft rag to wipe them out. Please do not put the whole handpiece into the water, in case of the water flow into the handpiece from behind.

### [after use, do not forget the lubrication before sterilizing under the high temperature and high pressure.]

As shown in figure, put the nozzle into the handpiece behind, spray for more than 2 seconds.

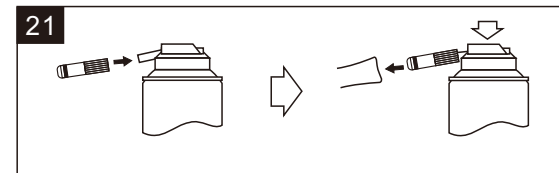

### ⚠ Note:

- When lubricating, please hold the hadnpiece tight, in case of the handpiece fly off due to the force of the spray air.
- In order to make the oil and gas completely mix, please shake the tank for some time.
- When lubricating, please be sure to clean up the lubrication oil tank.

If the head of the handpiece attach too much blood and dirt, need to be separately cleaned and refueled. Install the clean nozzle to it, and wash directly from inside.

If the water supply nozzle is stuck, please use the needle to clean it(Picture23).

If there is dirt around the nozzle, please use brush to clean it( Picture24).

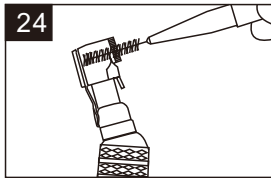
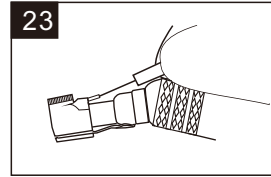
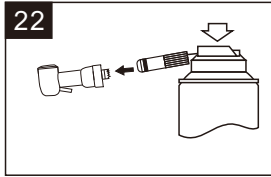

## Sterilization

High temperature and high pressure sterilization is recommended.

Every time after treatment, please follow the following methods to start the high temperature and high pressure sterilization.

The following parts are available under the high temperature and high pressure sterilization.

- Low speed handpiece
- Motor and its cord
- Motor supporter
- The nozzle for Internal water supply
- Clip for the water supply pipe
- Card ring for the water supply
- Anti-steam dossil

⚠ Note: Apart from the parts that are available under the high temperature and high pressure sterilization, the other (main unit, foot control, power cord, water supply pipe, Y type adaptor, fuse), please do not put into high temperature and high pressure sterilization

## High temperature and high pressure sterilization method

1. Please use the brush (not metal brush) to clean the attached dirt on the handpiece surface.
2. Lubricant the handpiece from inside. (Handpiece maintenance methods)  
Please do not oil the motor.  
Install the anti-steam dossil to the motor.
3. Put into the bag and seal for the high temperature and high pressure sterilization.
4. Use the temperature which is not more than 135 °C to sterilize. (such as: 121 °C 20min, or 132 °C 15min).

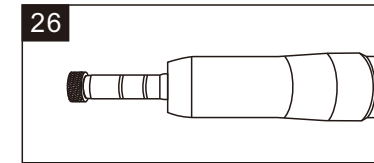
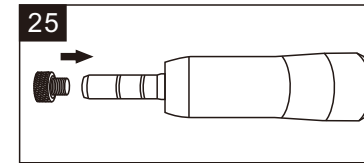

## Attention for High temperature and high pressure sterilization

1. Every time before the high temperature and high pressure sterilization, please clean and oil the handpiece. If the handpiece inside remains blood or dirt, then after the high temperature and high pressure sterilization, the remains will be solidified and cause the malfunction .
2. Please do not oil the motor inside.
3. Please do not unload motor and motor cord.
4. In the drying procedure, if the temperature inside is more than 135 °C, then please omit the drying process.
5. Because the supporter for the sterilization is close to the hot wire, the temperature somewhere may exceed the setting temperature, please put it onto the middle or upper level if possible.
6. Water supply pipe is disposable, and not intend for the high temperature and high pressure sterilization.

**Technical specifications**







## Main unit

Power source	AC230V 50/60Hz
Consumption power	120VA
Supply pump output	75mL/min

**Motor**

Speed	300~50,000r/min
Input voltage	DC30V

## Symbol definition

-  Type B applied part
-  Attention, consult accompanying documents
-  ON(power connection)
-  OFF(power disconnection)
-  Alternating Current
-  Manufacturers